

WPX 8 Typical Sectional Drawing

Sezione tipica pompe ad ingranaggi serie WPX 8 con trascinamento magnetico
 Typical sectional drawing gear pumps set WPX 8 with magnetic coupling

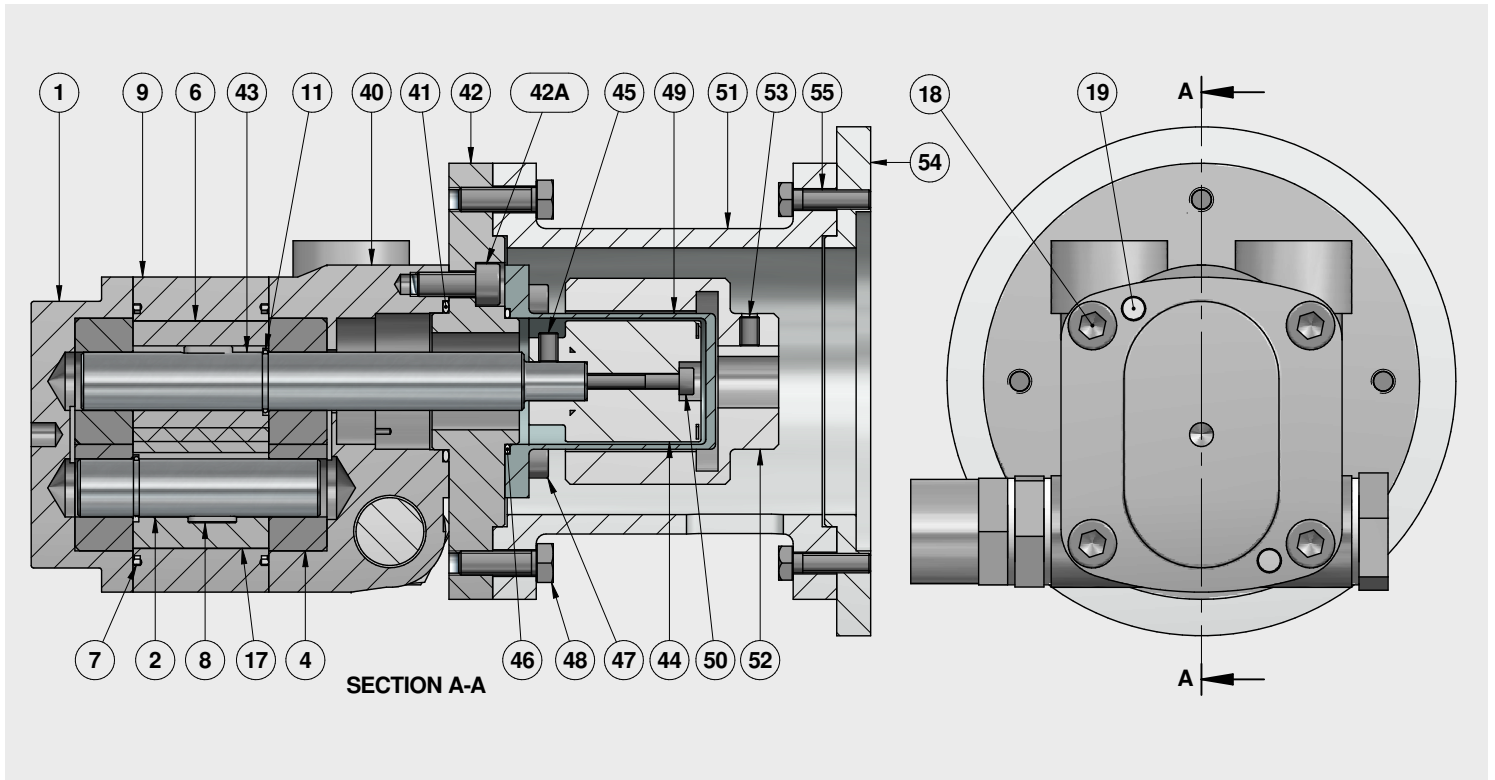

Lista parti - Materiali tra parentesi su richiesta
 *Parti di ricambio consigliate

Part list - Materials in brackets on request
 *Recommended spare parts

POS.	Q.TY	DESCRIZIONE DESCRIPTION	MATERIALE MATERIAL	STANDARD	POS.	Q.TY	DESCRIZIONE DESCRIPTION	MATERIALE MATERIAL	STANDARD
1	1	Coperchio posteriore Rear cover	X5CrNiMo17-12-2	UNI EN 10088/ AISI 316	42A	3	Vite Socket screw	X5CrNiMo17-12-2	UNI EN 10088/ AISI 316
2	1	Albero condotto Driven shaft	X5CrNiMo17-12-2	UNI EN 10088/ AISI 316	43	1	Albero conduttore Drive shaft	X5CrNiMo17-12-2	UNI EN 10088/ AISI 316
4	4	Boccola di supporto Supporting bush	X5CrNiMo17-12-2	UNI EN 10088/ AISI 316	44	1	Magnete interno Inner magnet	X5CrNiMo17-12-2	UNI EN 10088/ AISI 316
6	1	Ingranaggio conduttore Drive gear	X5CrNiMo17-12-2	UNI EN 10088/ AISI 316	45	1	Grano Grub screw	X5CrNiMo17-12-2	UNI EN 10088/ AISI 316
7*	2	O-ring	FKM (FFKM / EPDM)		46	1	O-ring	FKM (FFKM / EPDM)	
8	2	Linguetta Feather key	Acciaio inox Stainless steel		47	6	Vite Socket screw	X5CrNiMo17-12-2	UNI EN 10088/ AISI 316
9	1	Corpo centrale Main body	X5CrNiMo17-12-2	UNI EN 10088/ AISI 316	48	4	Vite TE Hexagonal head screw	Acciaio classe 8.8 Class 8.8 steel	
11	2	Circlip Circlip	X5CrNiMo17-12-2	UNI EN 10088/ AISI 316	49	1	Magnetic coupling cover	X5CrNiMo17-12-2	UNI EN 10088/ AISI 316
17	1	Ingranaggio condotto Driven gear	X5CrNiMo17-12-2	UNI EN 10088/ AISI 316	50	1	Vite Socket screw	X5CrNiMo17-12-2	UNI EN 10088/ AISI 316
18	4	Vite Socket screw	X5CrNiMo17-12-2	UNI EN 10088/ AISI 316	51	1	Lanterna Bellhousing	Alluminio Aluminium	
19	2	Spina di riferimento Dowel pin	X5CrNiMo17-12-2	UNI EN 10088/ AISI 316	52	1	Magnete esterno Outer magnet	X5CrNiMo17-12-2	UNI EN 10088/ AISI 316
40	1	Coperchio anteriore Front cover	X5CrNiMo17-12-2	UNI EN 10088/ AISI 316	53	1	Grano Grub screw	X5CrNiMo17-12-2	UNI EN 10088/ AISI 316
41	1	O-ring	FKM (FFKM / EPDM)		54	1	Flangia di adattamento Adjusting ring	Alluminio Aluminium	
42	1	Flangia Flange	Alluminio Aluminium		55	4	Vite TE Hexagonal head screw	Acciaio classe 8.8 Class 8.8 steel	

WPX 8 Typical Sectional Drawing

Sezione tipica pompe ad ingranaggi serie WPX 8 con trascinamento magnetico
 Typical sectional drawing gear pumps set WPX 8 with magnetic coupling

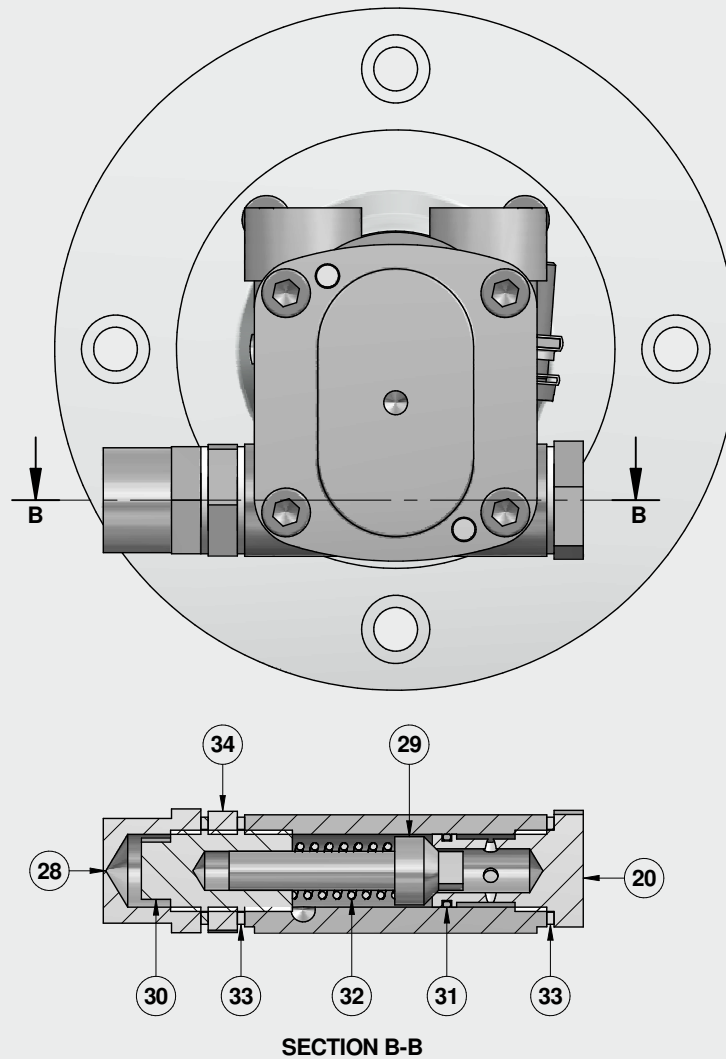

Lista parti - Materiali tra parentesi su richiesta
 *Parti di ricambio consigliate

Part list - Materials in brackets on request
 *Recommended spare parts

POS.	Q.TY	DESCRIZIONE DESCRIPTION	MATERIALE MATERIAL	STANDARD	POS.	Q.TY	DESCRIZIONE DESCRIPTION	MATERIALE MATERIAL	STANDARD
20	1	Sede valvola Valve seat	X5CrNiMo17-12-2	UNI EN 10088/ AISI 316	31*	1	O-ring	FKM (PTFE)	
28	1	Tappo di sicurezza Security cap	X5CrNiMo17-12-2	UNI EN 10088/ AISI 316	32	1	Molla valvola Valve spring	X5CrNiMo17-12-2	UNI EN 10088/ AISI 316
29	1	Otturatore Shutter	X5CrNiMo17-12-2	UNI EN 10088/ AISI 316	33	3	Guarnizione Gasket	Acciaio inox Stainless steel	
30	1	Vite di regolazione Adjusting screw	X5CrNiMo17-12-2	UNI EN 10088/ AISI 316	34	1	Dado Nut	X5CrNiMo17-12-2	UNI EN 10088/ AISI 316