

POMPE AD INGRANAGGI SERIE MX 5-25 A TRASCINAMENTO MAGNETICO
GEAR PUMPS RANGE MX 5-25 WITH MAGNETIC COUPLING

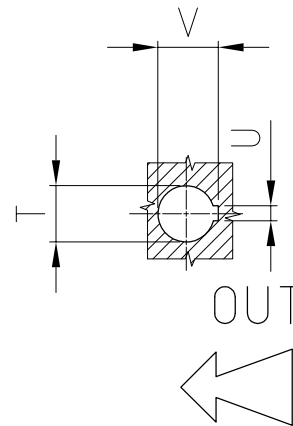

MX 5-25

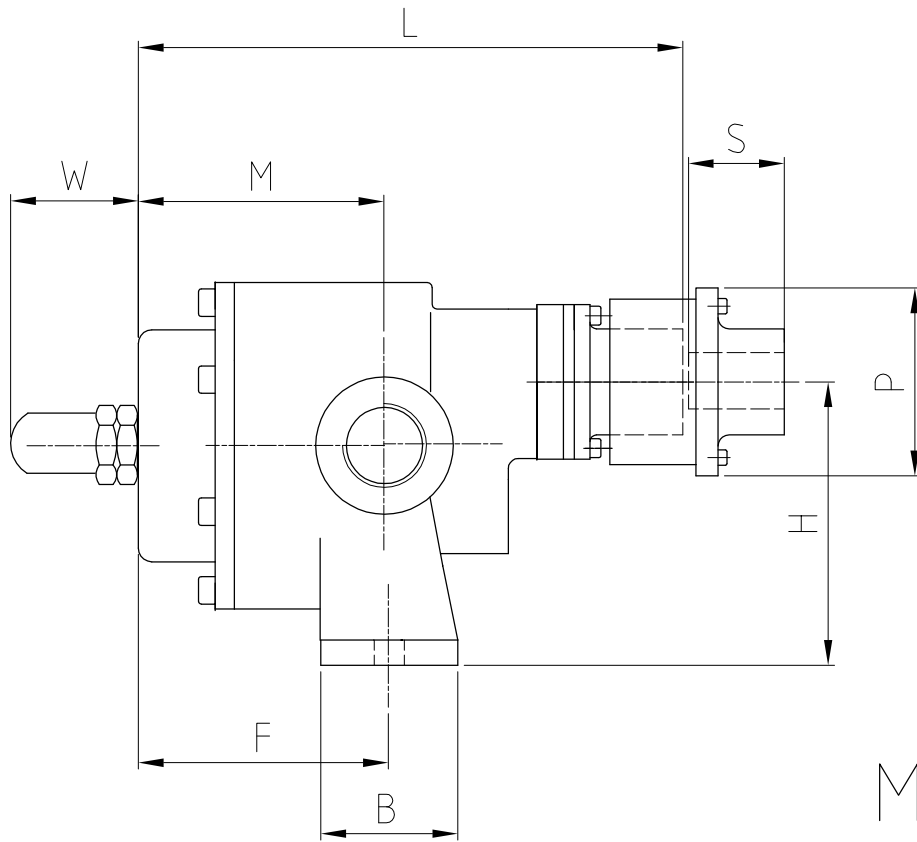
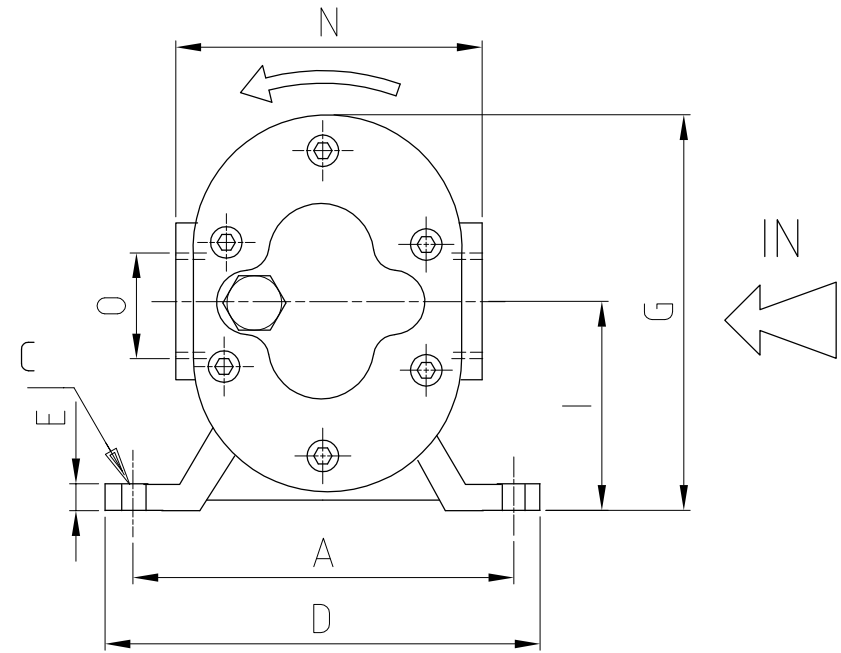

**POMPE AD INGRANAGGI SERIE MX 5-25 A TRASCINAMENTO MAGNETICO
GEAR PUMPS RANGE MX 5-25 WITH MAGNETIC COUPLING**

Tipo-Type	Dimensioni-Dimensions [mm] *																				
	A	B	C	D	E	F	G	H	I	L	M	N	O	P	Q***	Q1****	S	T**	U**	V**	W
MX5	106	40	11	130	7	52	115	80	64	142	52	98	3/4"	90	44	*	*	*	47
MX10	106	40	11	130	7	62	115	80	64	152	62	98	3/4"	90	44	*	*	*	47
MX15	106	40	11	130	7	72	115	80	64	162	72	98	3/4"	90	44	*	*	*	47
MX25	106	40	11	130	7	82	115	80	64	172	82	98	3/4"	90	44	*	*	*	47
MX40	125	40	11	145	8	70	136	100	76,5	185	70	138	1 1/2"	95	57	*	*	*	47
MX50	125	40	11	145	8	80	136	100	76,5	195	80	138	1 1/2"	95	57	*	*	*	47
MX70	125	40	11	145	8	90	136	100	76,5	205	90	138	1 1/2"	95	57	*	*	*	47
MX100	162	50	13	190	10	101	180	132	101	287	101	120	2"	120	160	210	60	*	*	*	54
MX150	162	50	13	190	10	121	180	132	101	307	121	120	2"	120	160	210	60	*	*	*	54

- * Dimensioni non impegnative - Dimensions are not binding
- ** Dipendono dalle dimensioni dell'albero motore - Depending on motor shaft dimensions
- *** Con controflangia standard - With standard counterflange
- **** Con controflangia S.A.E. - With S.A.E. counterflange